

Eclipse Series - NEMA 4, 12 Single Door Enclosures with Gland Plate

Industrial Enclosures
Wallmount Enclosures



Single Door with quarter turns



Single Door with 3 point latching handle



Application

- Designed to enclose electrical and/or electronic equipment and protect against harsh, industrial environments for wallmount applications
- Impressive styling features like hidden hinges, attractive latching systems make the Eclipse a suitable addition to any high-tech equipment installation.
- For high temperature applications, a gasket retainer may be required, please refer to factory.

Standards

- UL 508 Type 12, 4
- CSA Type 12, 4
- **Complies with**
 - NEMA Type 12 and 4
 - IEC 529, IP65

Construction

- Formed 14 or 16 gauge steel.
- Smooth, continuously welded seams ground smooth.
- Door stiffeners are provided where required for increased strength and rigidity - designed to also permit additional mounting options.
- Formed lip on enclosure to exclude flowing liquids and contaminants.
- Door latches feature the added safety of quarter turn slot requiring use of tool for opening.
- Doors may be easily removed for modifications and are interchangeable.
- Oil resistant gaskets are permanently secured.
- Collar studs provided for mounting inner panel.
- Includes hardware kit with panel mounting nuts and sealing washers for wall mounting holes.
- Bonding stud provided on door and grounding stud installed in enclosure.
- Quarter turn latches formed from mild steel (diecast key lockable handle with black epoxy finish on 3 point latch).
- Formed steel hinge with stainless steel hinge pins.
- Removable steel gland plate covers cutout in bottom allowing for easy cable entry preparation.

Finish

- Cover and enclosure are finished in recoatable textured RAL 7032 beige (CG1) powder coating.

Accessories

- Air conditioners...see page [348-357](#)
- Blowers...see page [359](#)
- Breather kits...see page [374](#)
- DIN rails...see page [35](#)
- DIN rail mounting kit...see page [35](#)
- Door stop kit...see page [393](#)
- Filter fans...see page [360-367](#)
- Heaters...see page [369-371](#)
- Handles...see page [36](#)
- Inner panel...see page [34](#)
- Quarter turn inserts and keys...see page [36](#)
- Literature pocket...see page [397](#)
- Mounting foot kit...see page [36](#)
- Swing frame...see page [35](#)
- Swing panel...see page [34](#)
- Replacement hinge pins...see page [34](#)
- Replacement quarter turn assemblies...see page [36](#)
- Thermostats...see page [374](#)
- Touch up paint...see page [396](#)
- UL/CSA approved hardware kit...see page [382](#)
- Padlock Adapter (EPA)...see page [382](#)

All dimensions in inches unless specified otherwise

Eclipse Series - NEMA 4, 12 Single Door Enclosures with Gland Plate

Industrial Enclosures
Wallmount Enclosures

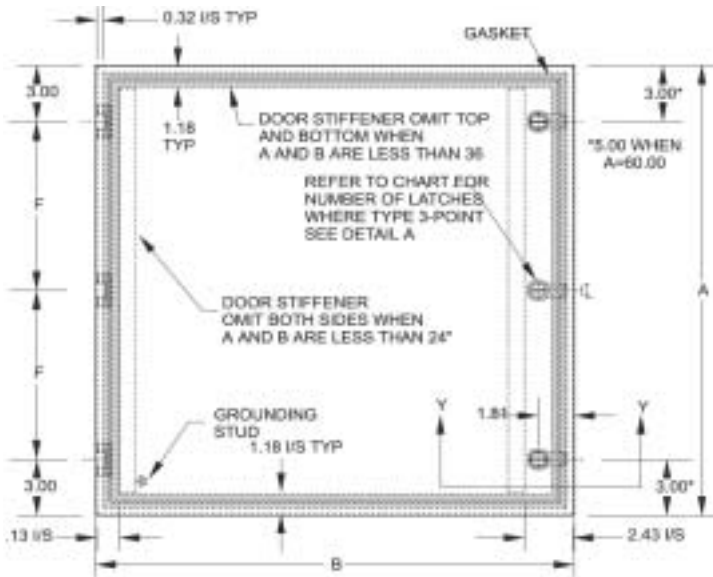

Front View

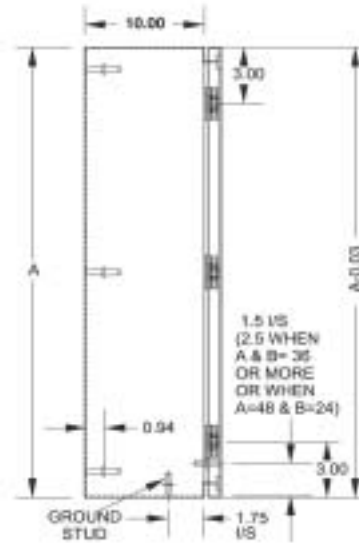

Side View
Hinge Side

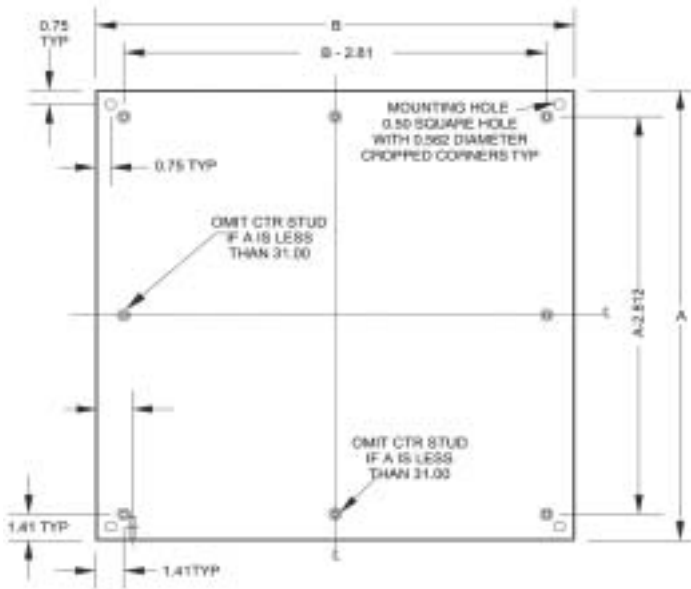

Front Section
(Door and Body Flange removed)

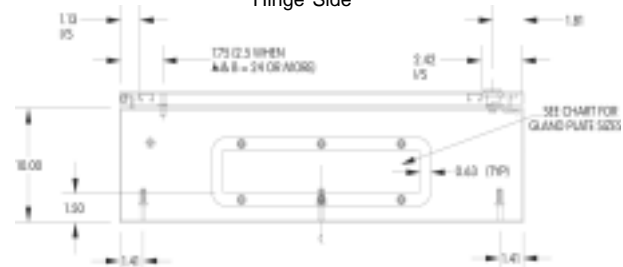

End View with Gland Plate

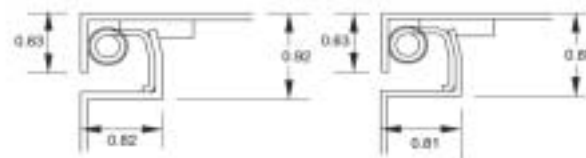

Cross Section of 14 Gauge Body & Door

Cross Section of 16 Gauge Body & Door

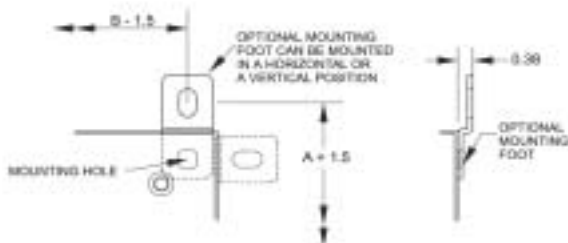

Mounting Detail
Door & Body Flange Removed

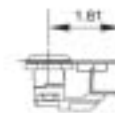

Quarter Turn Lock Section Y-Y

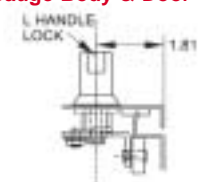

L Handle Lock Section X-X



Detail A

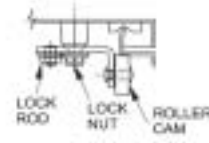

Cross Section Through End View

Door Cam Typ 2 pls when L handle is used

Refer to part number and dimension chart on previous page

All dimensions in inches unless specified otherwise

Quality Enclosures. Service Excellence.

© PDI COMMUNICATIONS, INC.

800.242.1606 or 561.998.0600

Data Subject to change without notice

Eclipse Series - NEMA 4, 12

Single Door Enclosures with Gland Plate

Continued from previous page.

Part No.	Overall Dimensions			Door/Body Gauge	Latches		Opt. Panel Part No.	Panel Size		GlandPlate Opening	# Hinges	Ship Wt. Lbs.	
	A	B	C		Qty	Type		D	E				
EN4SD363612CG	36	36	12	14	2	Qtr Turn	EP3636	34.2	34.2	19.63 x 4.63	3	15	104
EN4SD423612CG	42	36	12	14	1	3-point	EP4236	40.2	34.2	19.63 x 4.63	4	12	121
EN4SD482412CG	48	24	12	14	1	3-point	EP4824	46.2	22.2	19.63 x 4.63	4	14	98
EN4SD483612CG	48	36	12	14	1	3-point	EP4836	46.2	34.2	19.63 x 4.63	4	14	148
EN4SD603612CG	60	36	12	14	1	3-point	EP6036	58.2	34.2	19.63 x 4.63	4	18	165
EN4SD242416CG	24	24	16	14	2	Qtr Turn	EP2424	22.2	22.2	19.63 x 4.63	2	18	66
EN4SD363016CG	36	30	16	14	2	Qtr Turn	EP3630	34.2	28.2	19.63 x 4.63	3	15	102
EN4SD483616CG	48	36	16	14	1	3-point	EP4836	46.2	34.2	19.63 x 4.63	4	14	148
EN4SD242420CG	24	24	20	14	2	Qtr Turn	EP2424	22.2	22.2	19.63 x 4.63	2	18	70
EN4SD302420CG	30	24	20	14	2	Qtr Turn	EP3024	28.2	22.2	19.63 x 4.63	3	12	82
EN4SD363020CG	36	30	20	14	2	Qtr Turn	EP3630	34.2	28.2	19.63 x 4.63	3	15	117

Refer to drawing on following page
 * Does not meet Nema 4 requirements

Industrial Enclosures
Wallmount Enclosures

Optional Accessories

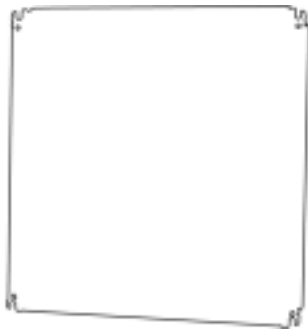

Inner panel...see page 34

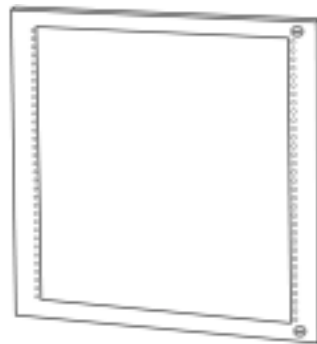

Swing frame...see page 35

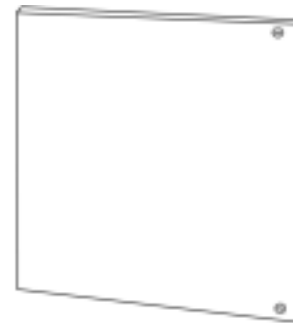

Swing panel...see page 34

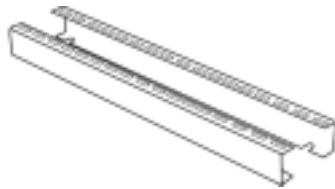

DIN rail mounting kit...see page 35

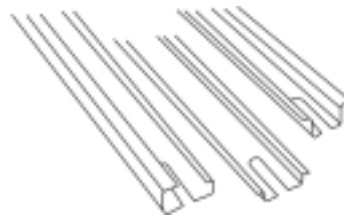

DIN rails...see page 35



Handles...see page 36



Quarter turn inserts and keys...see page 36



Mounting foot kit...see page 36

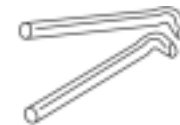

Replacement hinge pins...see page 34

Technical references and DXF downloads available at www.hammfg.com

All dimensions in inches unless specified otherwise

Quality Enclosures. Service Excellence.